

## Experimental research and finite element analysis of elastic and strength properties of fiberglass composite material

*Undergraduate E.A. Nekliudova;  
PhD, Associate Professor A.S. Semenov;  
Dr.tech.sci., Head of Department B.E. Melnikov;  
Engineer S.G. Semenov;  
Saint-Petersburg State Polytechnical University*

**Abstract.** This work is devoted to the research of the strength and elastic properties of the laminated fiberglass composite. Experiments were performed on tension and compression of specimens with different orientation of the reinforcement in relation to the loading direction. The predictions of three different failure criteria (Hill criterion, Tsai-Wu criterion, Zakharov criterion) were compared to experimental results.

The strength and elastic properties of the composite separate components have been also researched with the aim to perform finite element simulation of composite failure process. The elastic moduli of the composite are determined by means of the method of the finite element homogenization.

**Key words:** laminated composite; fiberglass material; experiment; elastic properties; strength; orientation of the reinforcement; failure criteria; orthotropic material; finite-element method

### Introduction

High strength, light weight, durability and affordability of modern composite materials make it possible to replace traditional, natural and man-made materials in all areas of life: in construction and reconstruction [1–3], mechanical engineering, shipbuilding, aerospace engineering. There are a lot of compositions of fibers [4] and matrixes [5]. However, correct analysis of strength and durability of construction elements made of composite materials requires development and application of new, complex criteria and their experimental verification. Various strength criteria and their comparison with experimental data for anisotropic composites are given in [6–9]. Modern literature is focused on the Tsai-Wu criterion. In this paper we consider three criteria – Hill, Tsai-Wu and Zacharov. Zacharov criterion has not been considered in modern literature and its predictions have not been compared with experimental data. Computation of elastic properties of composite materials is another problem of composite materials mechanics. Methods to determine effective elastic moduli of anisotropic materials by homogenization are considered in [10–12]. A finite-element homogenization method can be applied to anisotropic materials, One of the main problem of this method is how to determine the representative volume element correctly. In this work we consider a layered fiberglass composite, belonging to the orthotropic materials class. In reconstruction of a power plant pipeline that has lost its cross-section circular form because of long-term weight loads of overlying layers of soil [13], a problem rose related to obtaining properties of composite when strengthening the pipeline walls with this material.

The composite under study has a laminate structure, which represents an alternation of fiberglass fabric and epoxy resin. In this composite the fiberglass fabric T-23 made by TU 6-48-53-90 [14] is used. Properties of this fabric are presented in Table 1. Thickness of one layer of composite (fiberglass fabric + epoxy resin) is 1 mm. Fabric T-23 has a plain weave. The warp and weft are perpendicular to each other. Each layer of fiberglass fabric is placed evenly in manufacturing the composite.

**Table 1. Basic properties of the fiberglass fabric [14]**

| Parameter   | Value  |
|---|--------|
| Density (number of yarns per 1 cm) along the warp | 13±1   |
| Density (number of yarns per 1 cm) along the weft | 7±1    |
| Fiber width, mm                                   | 1.05   |
| Fiber thickness, mm                               | 0.12   |
| Surface density of the fabric, g/m <sup>2</sup>   | 285±25 |

The composite is considered an orthotropic material [15, 16]. Its elastic and strength properties depend on direction, but are symmetrical with respect to orthotropy axes 1, 2, 3 (Figure 1). Axes 1 and 2 coincide with directions of the warp and weft. In general, orthotropy axes do not coincide with global Nekliudova E.A., Semenov A.S., Melnikov B.E., Semenov S.G. Experimental research and finite element analysis of elastic and strength properties of fiberglass composite material

coordinates of the composite  $x, y, z$ . The stresses in the plane of reinforcement in the orthotropy axes and global coordinate system are interconnected in the following way [14]:

$$\begin{aligned} \sigma_1 &= \sigma_x \cos^2 \phi + \sigma_y \sin^2 \phi + \tau_{xy} \sin 2\phi, \\ \sigma_2 &= \sigma_x \sin^2 \phi + \sigma_y \cos^2 \phi - \tau_{xy} \sin 2\phi, \\ \tau_{12} &= (\sigma_y - \sigma_x) \cos \phi \sin \phi + \tau_{xy} \cos 2\phi, \end{aligned} \tag{1}$$

where  $\phi$  is an angle between the warp and axis  $x$ .

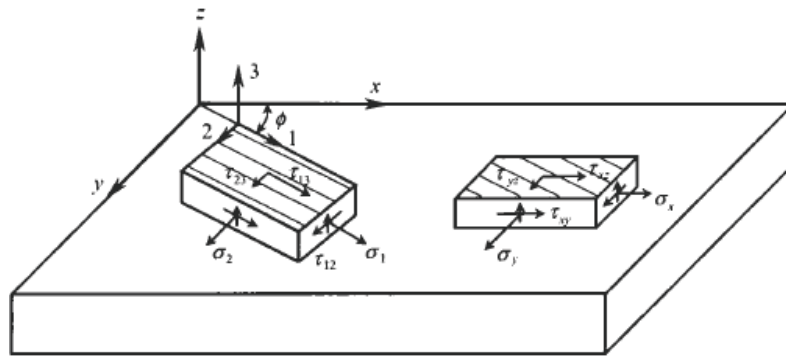

Figure 1. Orthotropy axes of the laminated fiberglass composite [17]

### Failure Criteria for Orthotropic Materials

The problem discussed in this section concerns evaluation of laminate load-carrying capacity [18, 19]. The failure criterion allows determining ultimate stresses that cause the composite fracture. Generally, failure criteria for an orthotropic material can be written in a compact form [20–22]:

$$F(\sigma_i, \tau_{ij}) = 1, \tag{2}$$

where  $\sigma_i, \tau_{ij}$  are components of the stress tensor written in the orthotropy axis. The composite works if  $F < 1$  and fails if  $F = 1$ . It does not exist as a load-carrying element if  $F > 1$ .

The criteria considered in this paper will be written for a composite in a plain stress state. It allows comparing the predictions of different criteria with the experimental results.

#### Hill Failure Criterion

We write the generalized von Mises criterion (square criterion)[19]:

$$\mathbf{s} \cdot \cdot \cdot \cdot \mathbf{V} \cdot \cdot \cdot \mathbf{s} = 1, \tag{3}$$

where  $\mathbf{s}$  is a deviator of the Cauchy stress tensor,  $\mathbf{V}$  is a tensor of 4<sup>th</sup> rank constants.

The generalized von Mises criterion recorded for an orthotropic material is the Hill failure criterion.

For an orthotropic material in plane stress state the Hill criterion, recorded in the orthotropy axis, is the following [22]:

$$\frac{\sigma_1^2}{\bar{\sigma}_1^2} + \frac{\sigma_2^2}{\bar{\sigma}_2^2} - \left( \frac{1}{\bar{\sigma}_1^2} + \frac{1}{\bar{\sigma}_2^2} - \frac{1}{\bar{\sigma}_3^2} \right) \sigma_1 \sigma_2 + \frac{\tau_{12}^2}{\bar{\tau}_{12}^2} = 1, \tag{4}$$

where  $\bar{\sigma}_i, \bar{\tau}_{ij}$  are ultimate (limiting) stresses determined experimentally.

It is assumed that the strength of the composite in direction 3 and in the direction at the angle of 45° to the warp is determined by the strength of the composite isotropic matrix, i.e. destruction occurs in

these areas at the same critical value of stress, it is denoted as  $\bar{\sigma}_T$ . Let  $\bar{\sigma}_T$  be a certain critical stress intensity. Then we have this relation:

$$\bar{\sigma}_T = \sqrt{3}\bar{\tau}_{12}, \quad (5)$$

then we find:

$$\bar{\tau}_{12} = \frac{\bar{\sigma}_{45^\circ}}{\sqrt{3}}. \quad (6)$$

Dependence of the limiting stress on the direction of the applied load can be obtained from the Hill failure criteria. Let us now consider the case of uniaxial tension. Let the load be applied along the x-axis. Angle  $\phi$  is the angle between the applied load and warp. After we substitute into (4), the formula for the stresses (1) and take into account (5) and (6), we obtain the following dependence:

$$\bar{\sigma}_x = \left[ \frac{\cos^4 \phi}{\bar{\sigma}_1^2} + \frac{\sin^4 \phi}{\bar{\sigma}_2^2} + \left( \frac{1}{\bar{\sigma}_{45^\circ}^2} - \frac{1}{\bar{\sigma}_1^2} - \frac{1}{\bar{\sigma}_2^2} \right) \cos^2 \phi \sin^2 \phi \right]^{\frac{1}{2}}. \quad (7)$$

The equation (7) shows dependence of the limiting stress on the angle between the applied load and warp. Since this dependence is based on the Hill failure criterion, the sign of the applied load is not taken into account. This is also true for tension and compression. The values of  $\bar{\sigma}_i$  are taken from a tensile experiment.

#### *Tsai-Wu Failure Criterion*

Let us consider the Tsai-Wu tensor-polynomial criterion [20]:

$$\mathbf{W}_1 \cdot \boldsymbol{\sigma} + \boldsymbol{\sigma} \cdot \mathbf{W}_2 \cdot \boldsymbol{\sigma} = 1, \quad (8)$$

or, in the index form:

$$F_i \sigma_i + F_{ij} \sigma_i \sigma_j = 1, \quad i, j = \overline{1, 6}. \quad (9)$$

Tsai-Wu criterion takes into account the sign of the applied load, because it contains linear summands on  $\sigma_i$ . Let us rewrite the criterion (9) for the orthotropic material in plane stress conditions [23, 24]:

$$F_1 \sigma_1 + F_2 \sigma_2 + F_{11} \sigma_1^2 + F_{22} \sigma_2^2 + F_{12} \sigma_1 \sigma_2 + F_{66} \tau_{12}^2 = 1. \quad (10)$$

The constants for Tsai-Wu criterion are defined as follows:

$$F_1 = \frac{1}{\bar{\sigma}_{1t}} - \frac{1}{\bar{\sigma}_{1c}}, \quad F_2 = \frac{1}{\bar{\sigma}_{2t}} - \frac{1}{\bar{\sigma}_{2c}}, \quad F_{11} = \frac{1}{\bar{\sigma}_{1t} \bar{\sigma}_{1c}}, \quad (11)$$

$$F_{22} = \frac{1}{\bar{\sigma}_{2t} \bar{\sigma}_{2c}}, \quad F_{12} = -2\sqrt{F_{11} F_{22}}, \quad F_{66} = \frac{1}{\bar{\tau}_{12}^2}$$

where index *t* is tension, index *c* is compression.

To obtain the dependence of the limiting stress on the direction of the applied load, we substitute in (10) the expression (1).  $\sigma_y = \tau_{xy} = 0$ . As result we obtain the equation for  $\bar{\sigma}_x$ :

$$A\bar{\sigma}_x^2 + B\bar{\sigma}_x = 1, \quad (12)$$

where

Nekliudova E.A., Semenov A.S., Melnikov B.E., Semenov S.G. Experimental research and finite element analysis of elastic and strength properties of fiberglass composite material

$$\begin{aligned}
 A &= F_{11} \cos^4 \varphi + F_{22} \sin^4 \varphi + (2F_{12} + F_{66}) \cos^2 \varphi \sin^2 \varphi, \\
 B &= F_1 \cos^2 \varphi + F_2 \sin^2 \varphi.
 \end{aligned}
 \tag{13}$$

When solving (12) with respect to  $\bar{\sigma}_x$ , we get two expressions of limiting stress on angle  $\phi$  between the applied load and warp:

$$\begin{aligned}
 \bar{\sigma}_{xc} &= \frac{-B - \sqrt{B^2 + 4A}}{2A} \text{ for compression.} \\
 \bar{\sigma}_{xt} &= \frac{-B + \sqrt{B^2 + 4A}}{2A} \text{ for tension.}
 \end{aligned}
 \tag{14}$$

Thus, on the basis of the Tsai-Wu criterion that takes into account the direction of the applied load, we obtain two different expressions of the limiting stress on the direction of the applied load.

### Zakharov Failure Criterion

The Zakharov criterion is a special case of the Gol'denblat-Kopnov criterion [25]:

$$\left( \prod_{ik} \sigma_{ik} \right)^\alpha + \left( \prod_{pqnm} \sigma_{pq} \sigma_{nm} \right)^\beta + \left( \prod_{rstlmn} \sigma_{rs} \sigma_{tl} \sigma_{nm} \right)^\nu + \dots = 1.
 \tag{15}$$

If in (15) we get only the first two invariants and put  $\alpha = \beta = 1$ , we obtain the Zakharov criterion.

The Zakharov criterion for orthotropic material in the plane stress state has the following form [22]:

$$\sigma_1^2 + A\sigma_2^2 + B\sigma_1\sigma_2 + C\sigma_1 + D\sigma_2 + E = 0.
 \tag{16}$$

Constants for the Zakharov criterion are defined as follows:

$$\begin{aligned}
 A &= \frac{\bar{\sigma}_{1t} \bar{\sigma}_{1c}}{\bar{\sigma}_{2t} \bar{\sigma}_{2c}}, \quad B = -1 - A - 4 \left( \frac{E + \frac{\bar{\sigma}_{45^\circ}}{2} (C + D)}{\bar{\sigma}_{45^\circ}^2} \right), \quad C = (\bar{\sigma}_{1c} - \bar{\sigma}_{1t}), \\
 D &= A(\bar{\sigma}_{2c} - \bar{\sigma}_{2t}), \quad E = -\bar{\sigma}_{1c} \bar{\sigma}_{1t}
 \end{aligned}
 \tag{17}$$

The Zakharov criterion, like the Tsai-Wu criterion, considers the sign of the applied load, but does not take into account the shear stress impact. Expressions for the limiting stress on the direction of the applied load are similar to the Tsai-Wu criterion:

$$\begin{aligned}
 \bar{\sigma}_{xc} &= \frac{-N - \sqrt{N^2 + 4ME}}{2M} \text{ for compression.} \\
 \bar{\sigma}_{xt} &= \frac{-N + \sqrt{N^2 - 4ME}}{2M} \text{ for tension.}
 \end{aligned}
 \tag{18}$$

where  $M = \cos^4 \phi + A \sin^4 \phi + D \cos^2 \phi \sin^2 \phi$ ,  $N = B \cos^2 \phi + C \sin^2 \phi$ .

## Experimental research of elasticity and strength properties of the composite

### Elasticity and strength properties of individual components of the composite

Determination of the elastic moduli and limiting stress of individual components of the composite is required to perform finite element analysis research of the elementary representative volume (RVE) of the composite. To determine the elastic moduli of the material components, tensile strength experiments on epoxy resin and glass fiber have been performed.

For the experiments, samples were made from the same epoxy resin as the one used in the composite. Sample sizes were 25×10×250 mm. The loading test was carried out on the Instron 8801 machine at the rate of 2 mm/min. Deformations were measured with an Instron 2620-603 strain gauge transducer, which was fixed to the broad side of the sample. As a result of the experiments, a stress-strain diagram was obtained for the epoxy resin (see Fig. 2), the Young's modulus was calculated and the limiting stress was defined (see Table 2). For each of the defined values the mean square deviation was calculated:

$$\delta = \sqrt{\frac{1}{n} \sum_{i=1}^n (x_i - \bar{x})^2} \quad (19)$$

where  $n$  is the number of experiments,  $x_i$  is the measured value,  $\bar{x}$  is the expectation (mean) value of the measured values.

**Table 2. Outcome of epoxy resin tensile strength experiment**

|                            | $\bar{\sigma}$ , MPa | E, MPa      |
|----------------------------|----------------------|-------------|
| Sample №1                  | 49.2                 | 3907        |
| Sample №2                  | 41.3                 | 3669        |
| Sample №3                  | 52.2                 | 3131        |
| <b>Expected value</b>      | <b>47.6</b>          | <b>3569</b> |
| <b><math>\delta</math></b> | <b>4.6</b>           | <b>325</b>  |

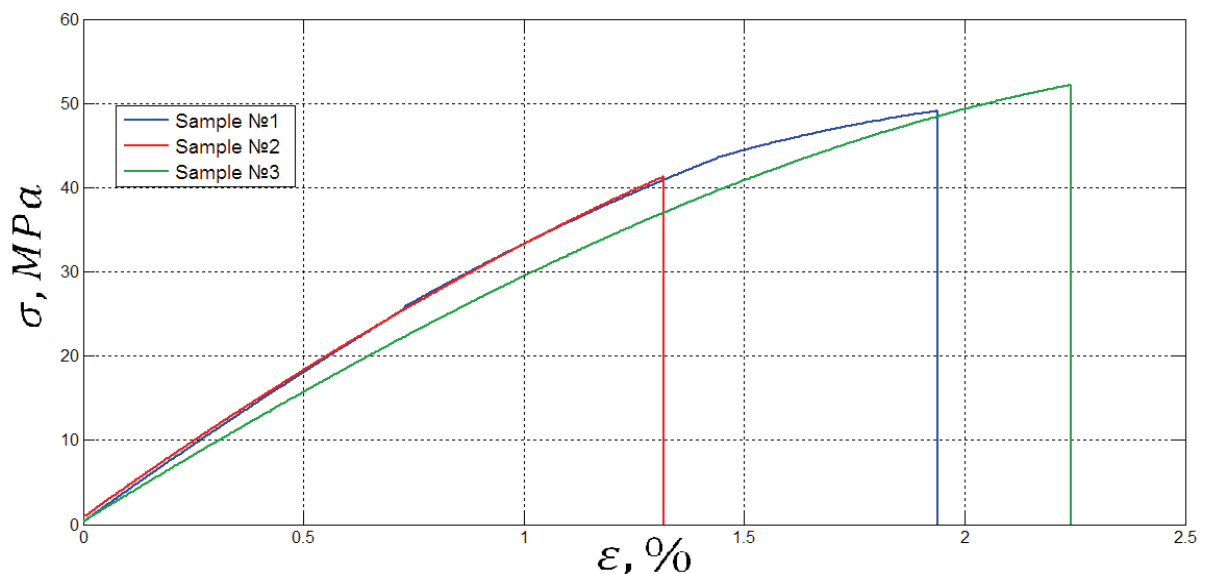

**Figure 2. Stress-strain diagram of the epoxy resin**

Additional experiments on tensile strength of samples were performed to determine the epoxy resin Poisson coefficient. The result for the epoxy resin is  $\nu = 0.2$ .

To determine properties of the glass fabric, extracted from fabric T-23, tensile strength experiments of glass yarns were performed. The ends of fiber were fanged with epoxy resin to place them into the grips of the testing machine. The length of the yarns outside the grips was 100 mm. A loading test was carried out on an Instron 5965 machine. The experiments resulted in obtaining a stress-strain diagram for glass yarn (see Fig. 3), calculating the Young's modulus and defining the limiting stress (see Table 3).

**Table 3. The Results of Experiments on Glass Yarn Tensile Strength**

|                            | $\bar{\sigma}$ , MPa | E, MPa    |
|----------------------------|----------------------|-----------|
| Sample №1                  | 1300                 | 60        |
| Sample №2                  | 1610                 | 80        |
| Sample №3                  | 756                  | 70        |
| <b>Expected value</b>      | <b>1222</b>          | <b>70</b> |
| <b><math>\delta</math></b> | <b>353</b>           | <b>8</b>  |

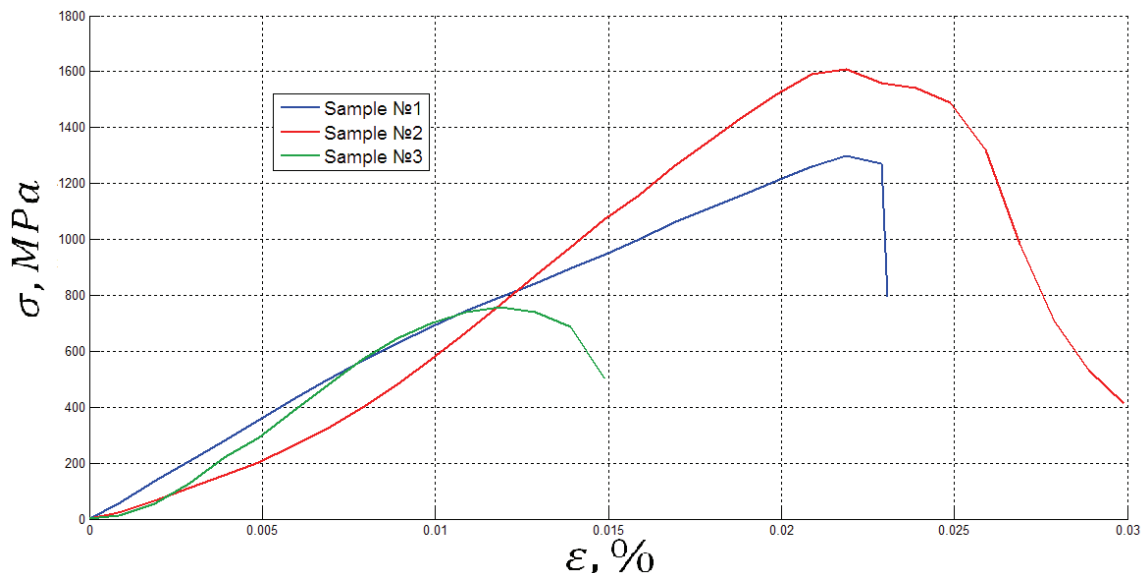

**Figure 3. Stress-strain diagram of glass yarn**

In further calculations we will accept the value of the glass Poisson coefficient as the glass fabric Poisson coefficient  $\nu = 0.23$ .

#### *Experimental research of elasticity and strength properties of the composite material*

Experiments were performed on tension and compression of fiberglass composite material samples at angles of  $0^\circ$ ,  $15^\circ$ ,  $30^\circ$ ,  $45^\circ$ ,  $60^\circ$ ,  $75^\circ$ ,  $90^\circ$  to the warp yarns, on an Instron 8801 testing machine, according to GOST 25.601–80 [26] and GOST 25.602–80 [27]. Deformations were measured with an Instron 2620-603 strain gauge transducer. Samples for tension had size  $25 \times 10 \times 140$  mm, the size of samples for compression was  $25 \times 10 \times 250$  mm. Stress-strain diagrams were obtained for tension and compression (see Fig. 4, 5), Both Young's moduli were calculated and the maximum values of stress  $\sigma^{\max}$  and limiting values of stress,  $\bar{\sigma}$ , at which the material is destroyed, were defined (see Table 4, 5).

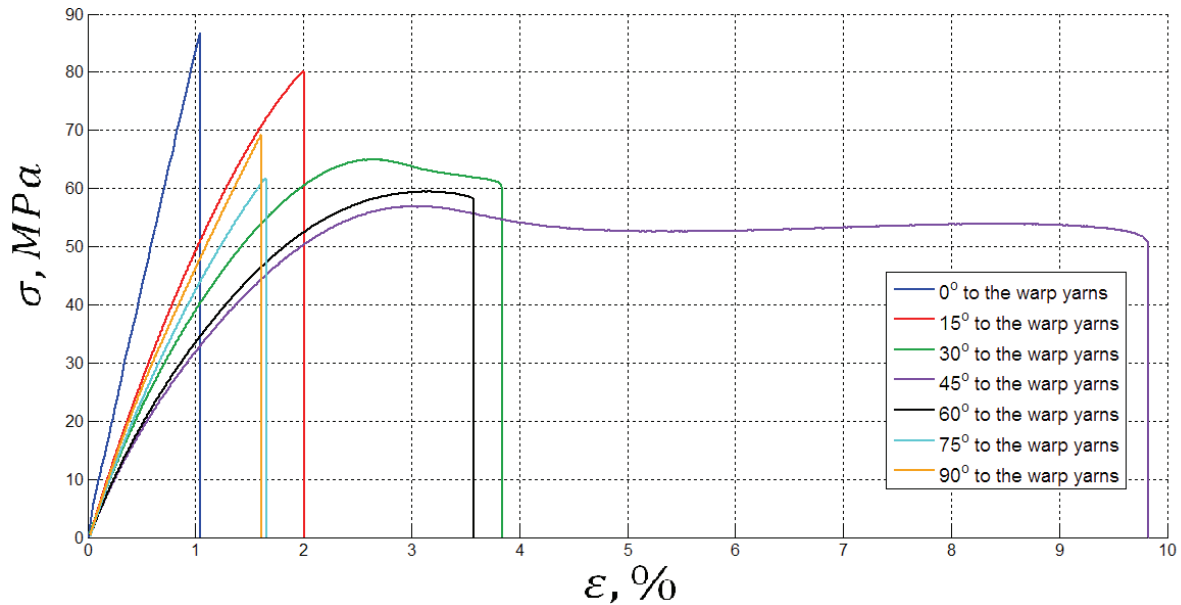

Figure 4. Stress-strain diagram of the composite in tension at different angles to the warp

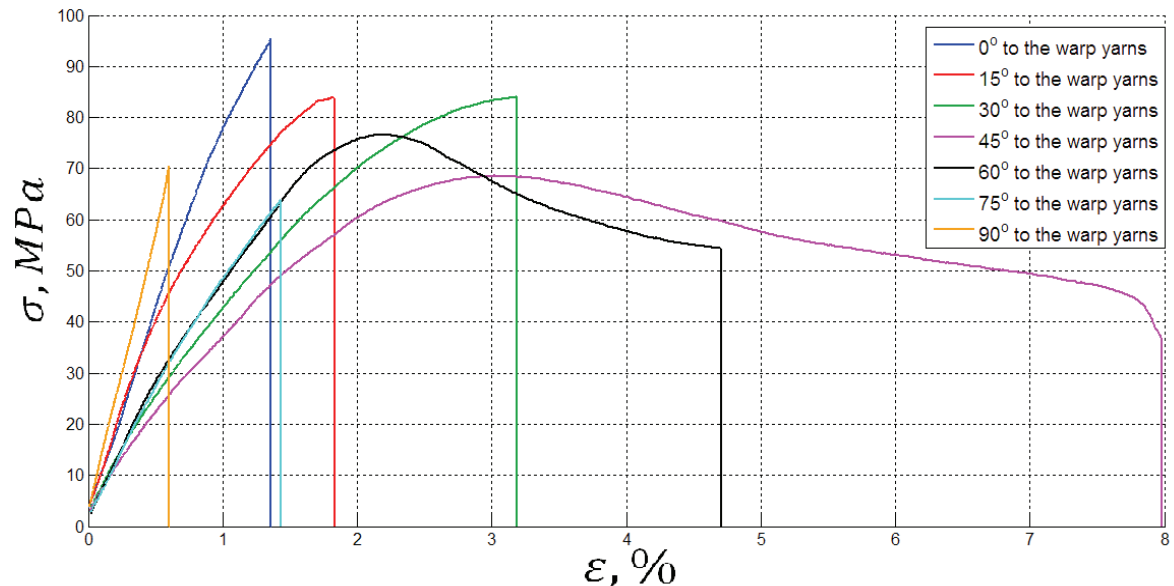

Figure 5. Stress-strain diagram of the composite in compression at different angles to the warp

Table 4. Result of experiments on composite tensile strength at different angles to the warp

| Angle between warp and applied load | 0°    | 15°   | 30°   | 45°   | 60°   | 75°   | 90°   |
|-------------------------------------|-------|-------|-------|-------|-------|-------|-------|
| $\bar{\sigma}$ , MPa                | 96.88 | 85.67 | 64.37 | 48.24 | 57.39 | 64.47 | 65.32 |
| $\sigma^{\max}$ , MPa               | 96.88 | 85.67 | 66.30 | 55.54 | 59.41 | 64.47 | 65.32 |
| E, MPa                              | 8308  | 5861  | 4539  | 3585  | 3969  | 4723  | 5427  |

Table 5. Result of experiments on composite compression strength at different angles to the warp

| Angle between warp and applied load | 0°    | 15°   | 30°   | 45°   | 60°   | 75°   | 90°   |
|-------------------------------------|-------|-------|-------|-------|-------|-------|-------|
| $\bar{\sigma}$ , MPa                | 93.72 | 84.33 | 83.46 | 50.84 | 57.09 | 67.48 | 68.02 |
| $\sigma^{\max}$ , MPa               | 93.72 | 84.33 | 83.46 | 71.33 | 77.56 | 67.48 | 68.02 |
| E, MPa                              | 7533  | 7667  | 5514  | 4627  | 5492  | 5526  | 12478 |

Nekliudova E.A., Semenov A.S., Melnikov B.E., Semenov S.G. Experimental research and finite element analysis of elastic and strength properties of fiberglass composite material

Photos of the broken samples are shown in Figures 6, 7.

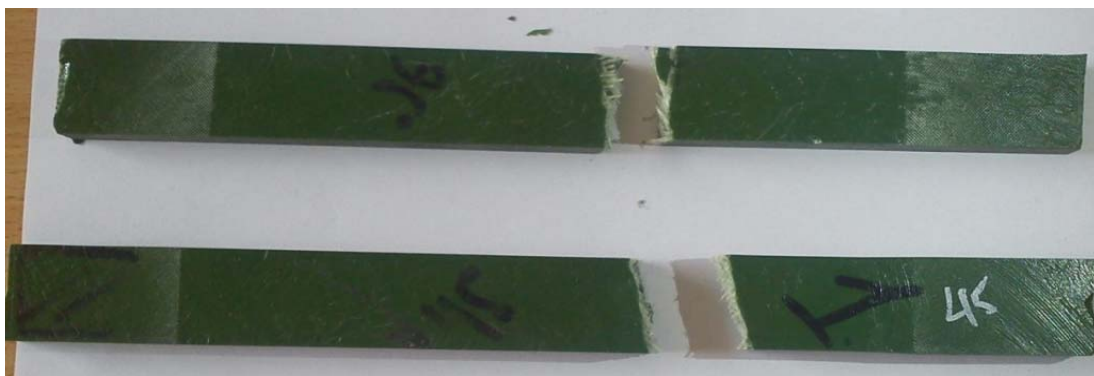

Figure 6. Samples broken under tension at angles 75° (above) and 45° (below) to the warp

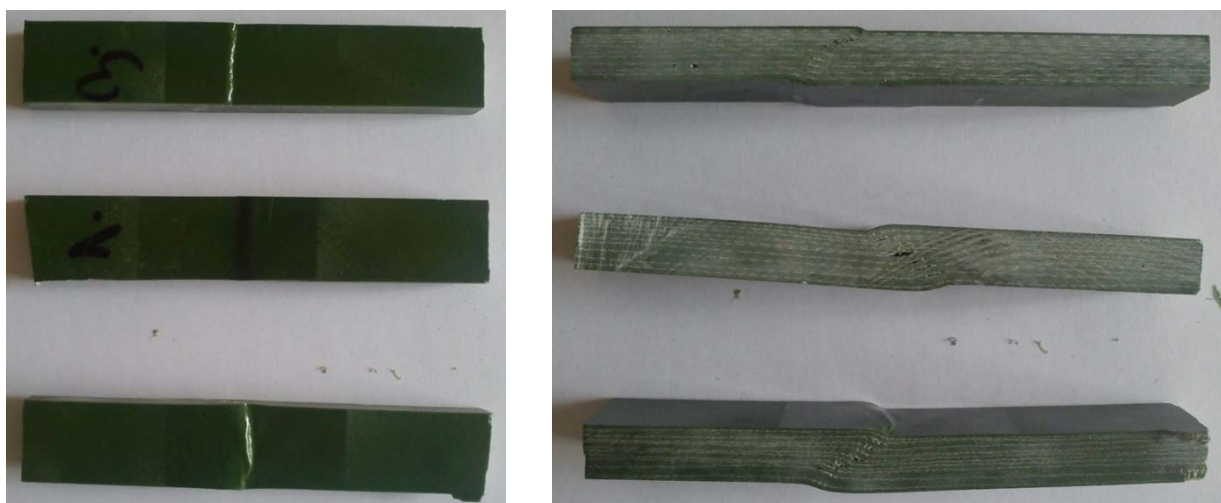

Figure 7. Samples broken under compression at angles (from top to bottom) 45°, 60°, 75° to the warp

Under tension the value of the limiting stress is  $\bar{\sigma}$ , the maximum stress is  $\sigma^{\max}$  and Young's modulus reaches the highest value with loading along the warp. The minimum values of the limiting stress  $\bar{\sigma}$ , the maximum stress  $\sigma^{\max}$  and the Young's modulus are observed under loading at the angle 45° to the warp yarns. It should be noted that under this loading the sample breaks at the stress of 48.24 MPa, which is almost exactly the same as the tensile strength of the epoxy resin.

The character of deformation diagrams varies depending on the type of loading. At 0°, 15°, 75° and 90° angles of loading the values of limiting and maximum stresses coincide. When a load is applied at 30°–75° angles these values differ. The form of the deformation diagram also varies: after reaching its maximum value, the stress begins to decrease, yield is reached and the highest values of deformation are obtained.

The fracture pattern is the same in all the cases: first, the epoxy resin breaks, then the fiberglass fabric is torn.

Under compression the maximum value of the Young's modulus is observed in compression across the warp, and this value is higher than the one for tension. The values of the limiting stress and the maximum stress reach their maximum level under the loading along the warp. The minimum value of the ultimate stress  $\bar{\sigma}$  is reached under the loading at the angle of 45° to the warp. This value is close to the ultimate strength of the epoxy resin. But the value of the maximum stress  $\sigma^{\max}$  increases compared to the tensile strength experiment. This may be due to the fact that under compression the bearing capacity of the sample is lost as a result of delamination of the material rather than complete destruction of the matrix, as it happens in tension. The minimum experimental value of  $\sigma^{\max}$  is reached under the loading at the angle of 75° to the warp yarns. The Young's modulus, as in the tensile strength experiment, is minimal at the angle of 45° to the warp.

Nekliudova E.A., Semenov A.S., Melnikov B.E., Semenov S.G. Experimental research and finite element analysis of elastic and strength properties of fiberglass composite material



The pattern of stress-strain diagrams is the same as the one in tension. Absence of yield plateau in the diagrams for compression at the angle of 30° may be caused by premature stopping of the experiment.

The mode of destruction is same in all the cases of compression: there is a local matrix and glass fiber delamination with the subsequent buckling of the yarns.

### *Comparison of Failure Criteria Predictions with Experimental Data*

To estimate how well the Hill, Tsai-Wu and Zakharov failure criteria predict the limited stress, we plotted relations (7), (13) and (18). Depending on what kind of experimental data will be substituted into the formula, we obtain dependence of the limiting stress  $\bar{\sigma}$  or maximum stress  $\sigma^{\max}$  on the angle between the applied load and the warp [28]. Plotted dependences are presented in Figures 8, 9. Experimental data points are plotted on graphs too.

Experimental results and results obtained on the basis of various criteria are shown in Tables 6, 7. For each criterion, the mean square deviation was counted from the experiment.

**Table 6. Comparison of the limiting stress obtained according to various criteria and experimental data**

| Value, MPa                  | Experiment | Hill criterion | Tsai-Wu criterion | Zakharov criterion |
|-----------------------------|------------|----------------|-------------------|--------------------|
| $\bar{\sigma}_{1t}$         | 96.88      | 96.88          | 96.88             | 96.88              |
| $\bar{\sigma}_{1c}$         | 93.72      | 96.88          | 93.72             | 93.72              |
| $\bar{\sigma}_{15^\circ t}$ | 85.67      | 74.55          | 78.09             | 74.77              |
| $\bar{\sigma}_{15^\circ c}$ | 84.33      | 74.55          | 76.40             | 73.217             |
| $\bar{\sigma}_{30^\circ t}$ | 66.30      | 54.80          | 59.09             | 54.93              |
| $\bar{\sigma}_{30^\circ c}$ | 83.46      | 54.80          | 58.71             | 54.60              |
| $\bar{\sigma}_{45^\circ t}$ | 48.24      | 48.24          | 52.04             | 48.24              |
| $\bar{\sigma}_{45^\circ c}$ | 50.84      | 48.24          | 52.39             | 48.54              |
| $\bar{\sigma}_{60^\circ t}$ | 57.39      | 50.20          | 53.25             | 50.11              |
| $\bar{\sigma}_{60^\circ c}$ | 57.09      | 50.20          | 54.32             | 51.05              |
| $\bar{\sigma}_{75^\circ t}$ | 64.47      | 58.66          | 60.17             | 58.57              |
| $\bar{\sigma}_{75^\circ c}$ | 67.48      | 58.66          | 62.21             | 60.50              |
| $\bar{\sigma}_{2t}$         | 65.32      | 65.32          | 65.32             | 65.32              |
| $\bar{\sigma}_{2c}$         | 68.02      | 65.32          | 68.02             | 68.02              |
| $\delta$                    | -          | <b>10.03</b>   | <b>7.89</b>       | <b>9.94</b>        |

**Table 7. Comparison of the maximum stress obtained according to various criteria and experimental data**

| Value, MPa                   | Experiment | Hill criterion | Tsai-Wu criterion | Zakharov criterion |
|------------------------------|------------|----------------|-------------------|--------------------|
| $\sigma_{1t}^{\max}$         | 96.88      | 96.88          | 96.88             | 96.88              |
| $\sigma_{1c}^{\max}$         | 93.72      | 96.88          | 93.72             | 93.72              |
| $\sigma_{15^\circ t}^{\max}$ | 85.67      | 80.70          | 83.21             | 80.87              |
| $\sigma_{15^\circ c}^{\max}$ | 84.33      | 90.67          | 88.70             | 88.45              |
| $\sigma_{30^\circ t}^{\max}$ | 66.30      | 62.77          | 66.33             | 62.89              |
| $\sigma_{30^\circ c}^{\max}$ | 83.46      | 79.54          | 79.45             | 78.91              |
| $\sigma_{45^\circ t}^{\max}$ | 55.54      | 55.54          | 58.73             | 55.54              |
| $\sigma_{45^\circ c}^{\max}$ | 71.33      | 71.33          | 72.53             | 71.99              |
| $\sigma_{60^\circ t}^{\max}$ | 59.91      | 56.10          | 58.45             | 56.02              |
| $\sigma_{60^\circ c}^{\max}$ | 77.56      | 67.11          | 69.14             | 68.79              |
| $\sigma_{75^\circ t}^{\max}$ | 64.47      | 61.52          | 62.49             | 61.45              |
| $\sigma_{75^\circ c}^{\max}$ | 67.48      | 65.61          | 68.13             | 68.01              |
| $\sigma_{2t}^{\max}$         | 65.32      | 65.32          | 65.32             | 65.32              |
| $\sigma_{2c}^{\max}$         | 68.02      | 65.32          | 68.02             | 68.02              |
| $\delta$                     | -          | <b>4.19</b>    | <b>3.05</b>       | <b>3.53</b>        |

According to the results of all the experiments the smallest mean square deviation is observed in the Tsai-Wu criterion, which takes into account the sign of the applied load and influence of shear stresses.

The premature stopping of the experiment on compression at the angle of  $30^\circ$  to the warp explains a sufficient error for  $\sigma_{30^\circ c}$ .

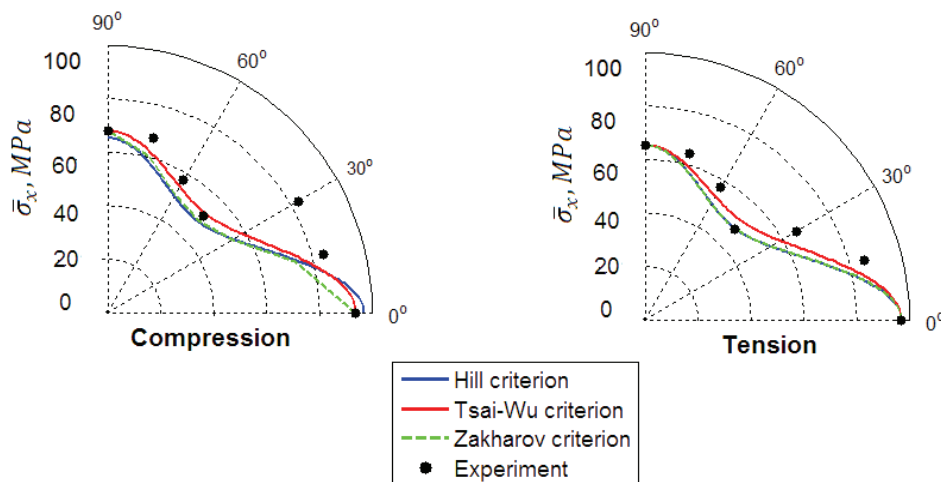

**Figure 8. Dependence of limiting stress on the direction of the applied load for compression and tension**

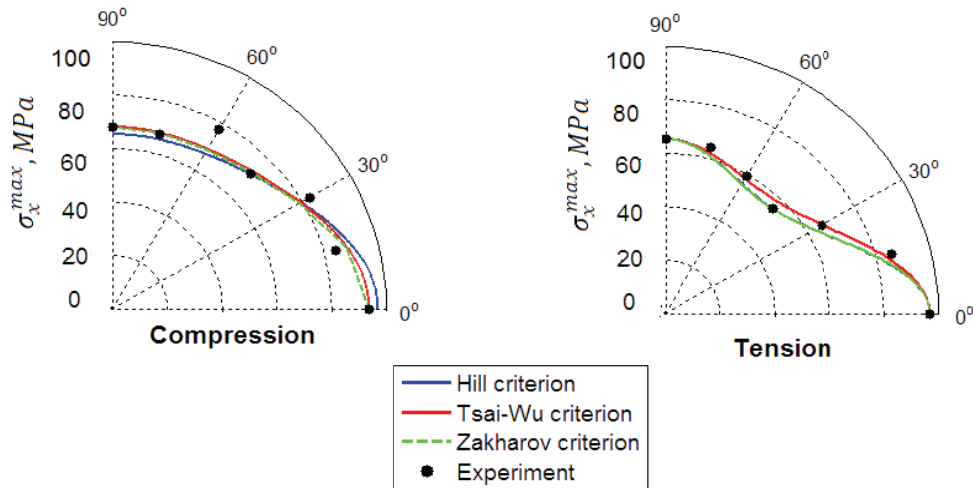

Figure 9. Dependence of maximum stress on direction of the applied load for compression and tension

### Results of Finite Element Modeling

The finite element model of the representative volume element of the composite is shown in Fig. 10, 11. For this, the composite representative volume element is a single cell of plain weave [10, 29]. Parameters of the model are presented in Tables 8, 9. The material properties are specified from the experimental results.

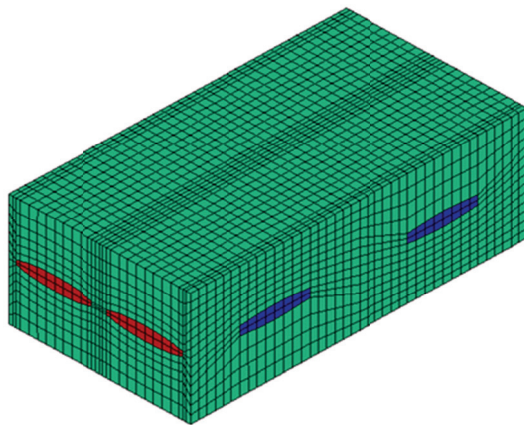

Figure 10. Finite element model of the representative volume element of the laminated fiberglass composite

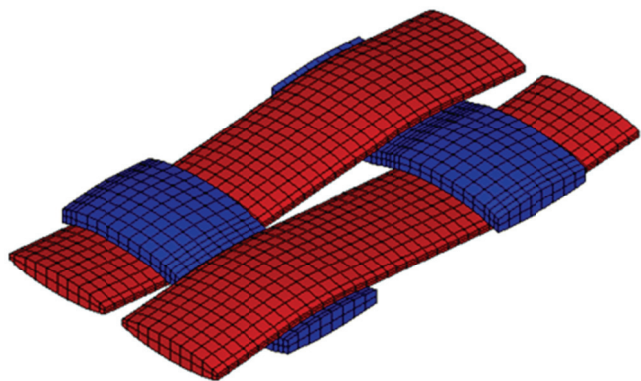

Figure 11. Plain weave within the representative volume element of the laminated fiberglass composite (red yarn is warp, blue yarn is weft)

Table 8. Parameters of the FE-model

| Parameter          | Value  |
|--------------------|--------|
| Element type       | Solid  |
| Number of elements | 20867  |
| Number of nodes    | 73671  |
| Number of DOFs     | 221013 |

Table 9. Material properties

| Material   | Material  | E, MPa             |      |
|------------|-----------|--------------------|------|
| Epoxy      | Isotropic | 3569               | 0.20 |
| Glass yarn | Isotropic | 70·10 <sup>3</sup> | 0.23 |

So as to calculate the elastic moduli of the composite, numerical experiments were performed on the representative volume element under tension in three main directions, and under shear in three planes. The stresses and strains are calculated by averaging over the elementary volume [30]:

$$\langle \sigma \rangle = \frac{1}{V} \int_V \sigma dV, \tag{20}$$

$$\langle \varepsilon \rangle = \frac{1}{V} \int_V \varepsilon dV. \tag{21}$$

where  $V$  is the volume of the representative volume element.

Examples of stress and strain field distributions are shown in Figures 12,13.

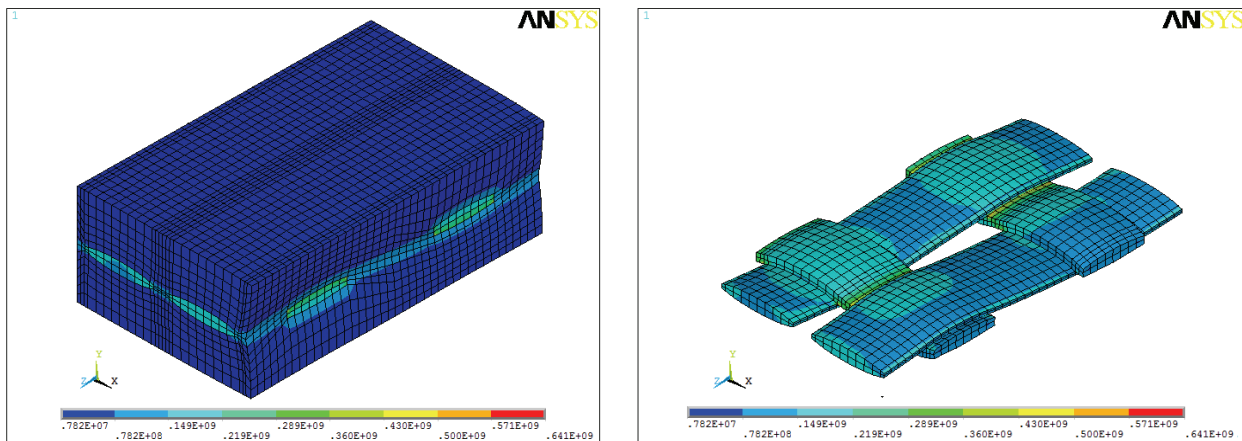

Figure 12. The distribution of stress field  $\sigma_2$  under tension along the weft

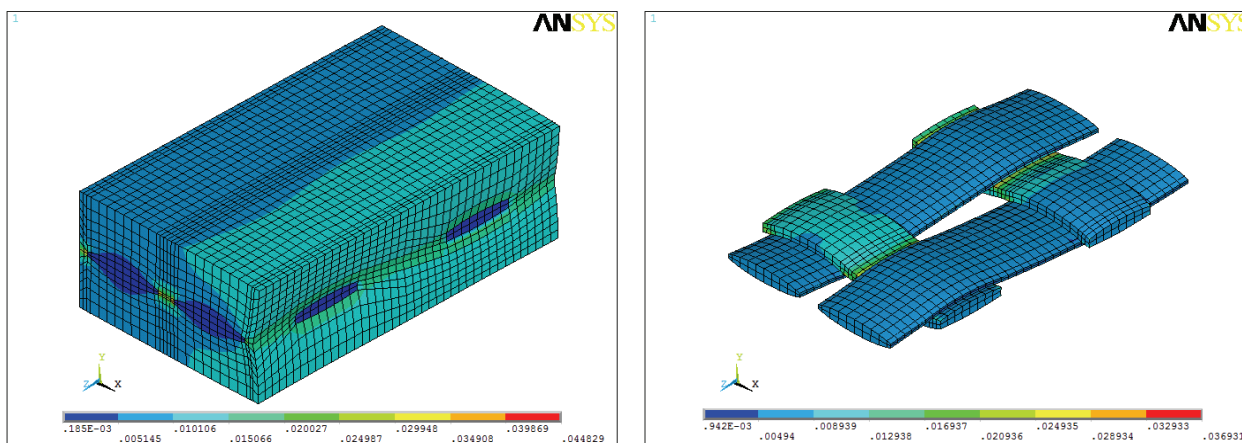

Figure 13. The distribution of the strain field  $\varepsilon_2$  under tension along the weft

If we use finite element homogenization, we obtain 9 elastic constants of the composite. The results are presented in Table 10.

Table 10. Elastic moduli of the composite obtained by the finite element homogenization

| Constant   | Value    |
|------------|----------|
| $E_{11}$   | 8417 MPa |
| $E_{22}$   | 5511 MPa |
| $E_{33}$   | 4257 MPa |
| $\nu_{12}$ | 0.160    |
| $\nu_{13}$ | 0.217    |
| $\nu_{23}$ | 0.225    |
| $G_{12}$   | 2356 MPa |
| $G_{13}$   | 1764 MPa |
| $G_{23}$   | 1797 MPa |

Since the composite under consideration belongs to the orthotropic materials class we have the following dependence on direction for its Young's modulus [14]:

$$E_x = \left[ \frac{\cos^4 \phi}{E_{11}} + \left( \frac{1}{G_{12}} - \frac{\nu_{12}}{E_{11}} \right) \cos^2 \phi \sin^2 \phi + \frac{\sin^4 \phi}{E_{22}} \right]^{-1} \quad (22)$$

To check consistency of the results, obtained through finite element computations, with experimental data, we plot the dependence of Young's modulus  $E_x$  of the angle between the warp and the x-axis. We substitute in (22), the data from table 10 and compare the results with the experiment. For each value of the Young's modulus the error is calculated by formula:

$$\Delta = \left| \frac{E_{X_{FE}} - E_{X_E}}{E_{X_E}} \right| \cdot 100\%, \quad (23)$$

where  $E_{X_{FE}}$  is FE-modeling results,  $E_{X_E}$  is experimental results.

The results are presented in Table 11 and in Figure 14.

**Table 11. Comparison of the Young's modulus depends on the angle between the x-axis and the warp yarn, and is done with the data from FE-calculation and experiment**

| Value          | Experiment, MPa | FE-calculation, MPa | $\Delta$ , % |
|----------------|-----------------|---------------------|--------------|
| $E_{11}$       | 8308            | 8417                | 1.31         |
| $E_{15^\circ}$ | 5861            | 5944                | 1.42         |
| $E_{30^\circ}$ | 4539            | 4167                | 8.20         |
| $E_{45^\circ}$ | 3585            | 3647                | 1.73         |
| $E_{60^\circ}$ | 3969            | 3867                | 2.57         |
| $E_{75^\circ}$ | 4723            | 4747                | 0.51         |
| $E_{22}$       | 5427            | 5532                | 1.93         |

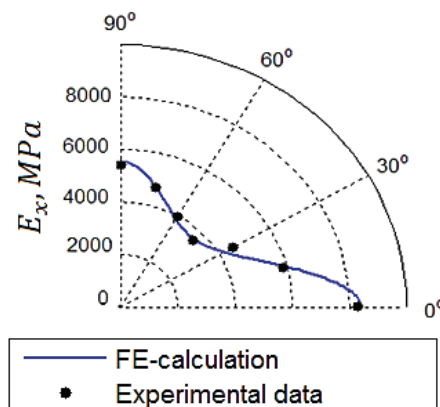

**Figure 14. Comparison of the experimental and FE-homogenized Young's modulus for different angles between the x-axis and the warp yarn**

The comparison is made with the tensile strength experiment, as neither dependence (22), nor built model take into account the differences between properties of the material in tension and compression. Results of the FE computation demonstrate satisfactory consistence with the experiment. When comparing it should be noted that the properties of epoxy resin and glass fiber, defined in the finite element model, have been determined experimentally, which could affect the accuracy of calculation. It should be also taken into account that the experimental data may differ slightly from the actual properties of the composite.

Nekliudova E.A., Semenov A.S., Melnikov B.E., Semenov S.G. Experimental research and finite element analysis of elastic and strength properties of fiberglass composite material

## Conclusions

1. Experiments for determination of the ultimate (limit) stresses in tension and compression for different orientations of the load direction with respect to the warp yarns have been made on the laminated fiberglass composite specimens. There is a pronounced anisotropy of the mechanical properties and their sensitivity to the stress form (the difference in tension and compression).

2. Dependences of limiting stresses on the angle between the load application and warp yarns is obtained based on various failure criteria. There is a decrease of limiting stresses when load is applied to the corners at the range of 30–60° caused by redistribution of load between the matrix and the reinforcement to the side increasing the load on the epoxy resin. The criteria considering the effect of the first invariant of stress (Tsai-Wu and Zakharov) can predict more accurately the strength of the material at the entire range of loads (both in tension and in compression). However, more experiments are required to identify the constants.

3. The finite element model of the representative volume element of the composite has been proposed. The effective elastic properties of the composite have been determined with the use of the finite element analysis. The simulation results coincide satisfactorily with the experimental data. Further improvement of the model will allow determining in the future the properties of the composite without complex, lengthy and costly experiments.

## References

1. Parancheva N.V., Nazmeyeva T.V. Usileniye stroitelnykh konstruksiy s pomoshchyu uglerodnykh kompozitsionnykh materialov [Strengthening of building structures using carbon composite materials]. *Magazine of Civil Engineering*. 2010. No. 2(12). Pp. 19–22. (rus)
2. Klyuyev S.V., Guryanov Yu.V. Vneshneye armirovaniye izgibayemykh fibrobetonnykh izdeliy uglevoloknom [External reinforcing of fiber concrete constructions by carbon fiber tapes]. *Magazine of Civil Engineering*. 2013. No. 1(36). Pp. 21–26. (rus)
3. Morozova T.S., Kuznetsov V.D. Vneshneye armirovaniye zhelezobetonnykh kolonn kompozitsionnym materialom na osnove uglevolokon [External reinforcement of concrete columns with composite material based on carbon fibers]. *Magazine of Civil Engineering*. 2010. No. 3(13). Pp. 35–38. (rus)
4. Stolyarov O.N., Gorshkov A.S. Primeniye vysokoprochnykh tekstilnykh materialov v stroitelstve [Use high-strength textile materials in construction]. *Magazine of Civil Engineering*. 2009. No. 4(6). Pp. 21–25. (rus)
5. Stolyarov O.N., Stolyarov I.N., Kryachkova T.A., Kravaev P.G. Hybrid textile yarns and thermoplastic composites based on them. *Fibre Chemistry*. 2013. No. 4. Pp. 217–220.
6. Echaabi J., Trochu F., Gauvin R. Review of failure criteria of fibrous composite materials. *Polymer Composites*. 1996. No. 6. Pp. 786–798.
7. Moncada A.M., Chattopadhyay A., Bednarczyk B.A., Arnold S.M. Micromechanics-based progressive failure analysis of composite laminates using different constituent failure theories. *Journal of Reinforced Plastics and Composites*. 2012. No. 31. Pp. 1467–1487.
8. Kaddour A.S., Hinton M.J. Maturity of 3D failure criteria for fibre-reinforced composites: Comparison between theories and experiments: Part B of WWFE-II. *Journal of Composite Materials*. 2013. No. 47. Pp. 925–966.
9. Qian Y., Zhou G., Cai D., Liu W. Investigation of strength criterion for biaxial fiber-reinforced composite laminated plates. *Journal of Nanjing University of Aeronautics and Astronautics*. 2013. No. 45. Pp. 179–185.
10. Li H., Kandare E., Li S., Wang Y., Kandola B.K., Myler P., Horrocks A.R. Micromechanical finite element analyses of fire-retarded woven fabric composites at elevated temperatures using unit cells at multiple length scales. *Computational Materials Science*. 2012. No. 55. Pp. 23–33.
11. Kalamkarov A.L., Challagulla K.S. Effective properties of composite materials, reinforced structures and smart composites: Asymptotic homogenization approach. *Solid Mechanics and its Applications*. 2013. No. 193. Pp. 283–363.
12. Li H., Fan X., Yan C. Prediction of orthotropic mechanical properties of plain-weave composites with matrix voids using unit cells at multi-scales. *Polymer International*. 2013. No. 62. Pp. 1029–1037.
13. Fedorov I.V., Semenov S.G., Semenov A.S., Melnikov B.Ye. Analiz prochnosti, ustoychivosti i zhestkosti vodovoda iz kompozitsionnogo materiala [An analysis of strength, buckling and rigidity of composite material water piping]. *St. Petersburg State Polytechnical University Journal. Physics and Mathematics*. 2012. No. 4 (158). Pp. 126–134. (rus)

Nekliudova E.A., Semenov A.S., Melnikov B.E., Semenov S.G. Experimental research and finite element analysis of elastic and strength properties of fiberglass composite material

14. TU 6-48-53-90. *Tkani steklyannyye marok T-23 i T-23R. Tekhnicheskiye usloviya* [Textile glass grades T-23 and T-23P. Specifications]. (rus)
15. Vasiliev V.V., Morozov E.V. *Mechanics and analysis of composite materials*. Oxford: Elsevier Science Ltd., 2001. 430 p.
16. Kim R.Y., Abrams F., Knight M. Mechanical characterization of a thick composite laminate. In: *Proceedings of American Society of Composites, 3rd Technical Conference*. Seattle, Washington, USA, September 1988. Pp. 711–718.
17. Vasilyev V.V. *Mekhanika konstruksiy iz kompozitsionnykh materialov* [Mechanics of composite structures]. Moscow: Mashinostroyeniye, 1988. 272 p. (rus)
18. Tsai S.W., Wu E.M. A General Theory of Strength for Anisotropic Materials. *Journal of Composite Materials*. 1971. No. 5. Pp. 58–80.
19. Malinin N.N. *Prikladnaya teoriya plastichnosti i polzuchesti* [Applied Theory of Plasticity and Creep]. Moscow: Mashinostroyeniye, 1975. 400 p. (rus)
20. Kristensen R.M. *Mekhanika kompozitsionnykh materialov* [Mechanics of Composite Materials]. Moscow: Mir, 1982. 336 p. (rus)
21. Christensen R.M. The Number of Elastic Properties and Failure Parameters for Fiber Composites. *Journal of Engineering Material and Technology*. 1998. Vol. 120(2). Pp. 110–113.
22. Hill R. *The mathematical theory of plasticity*. Oxford: Clarendon Press, 1950. 392 p.
23. Steven J. DeTeresa, Gregory J. Larsen. Reduction in the Number of Independent Parameters for the Tsai–Wu Tensor Polynomial Theory of Strength for Composite Materials. *Journal of Composite Materials*. 2003. No. 19. Pp. 1769–1785.
24. Sulaimana S., Borazjani S., Tang S.H. Finite element analysis of filament-wound composite pressure vessel under internal pressure. *IOP Conference Series: Materials Science and Engineering*. 2013. Vol. 50. No. 1. 012061
25. Goldenblat I.I., Kopnov V.A. *Kriterii prochnosti i plastichnosti konstruksionnykh materialov* [The criteria of strength and ductility of structural materials]. Moscow: Mashinostroyeniye, 1968. 192 p. (rus)
26. GOST 25.601–80. *Raschety i ispytaniya na prochnost. Metody mekhanicheskikh ispytaniy kompozitsionnykh materialov s polimernoy matritsey (kompozitov). Metod ispytaniya ploskikh obratsov na rastyazheniye pri normalnoy, povyshennoy i ponizhennoy temperaturakh* [Calculations and tests of strength. Methods of mechanical testing of composite materials with a polymer matrix (composites). Test Method for Tensile flat samples with normal, low and high temperatures]. (rus)
27. GOST 25.602–80. *Raschety i ispytaniya na prochnost. Metody mekhanicheskikh ispytaniy kompozitsionnykh materialov s polimernoy matritsey (kompozitov). Metod ispytaniya na szhatiye pri normalnoy, povyshennoy i ponizhennoy temperaturakh* [Calculations and tests of strength. Methods of mechanical testing of composite materials with a polymer matrix (composites). The method of compression testing of flat samples with normal, low and high temperatures.]. (rus)
28. Wu. E.M. Optimal Experimental Measurements of Anisotropic Failure Tensors. *Journal of Composite Materials*. 1972. No. 6. Pp. 472–489.
29. Spoomaker, J., Skrypnyk, I., Stolyarov, O.N., Tiranov, V.G., Heidweiller, A.J. Mechanical properties of plastics for FEM calculations. *ANTEC conference proceedings*. 2004. No. 3. Pp. 3893–3897.
30. Besson Zh., Kayeto Zh., Shabosh Zh.-L., Forest S. *Nelineynaya mekhanika materialov* [Nonlinear Mechanics of Materials]. Saint-Petersburg: SPbGPU, 2010. 397 p. (rus)

Ekaterina A. Nekliudova, St.-Petersburg, Russia  
+7(921)9253778; e-mail: nekludik@mail.ru

Artem S. Semenov, St.-Petersburg, Russia  
+7(905)2721188; e-mail: Semenov.Artem@googlemail.com

Boris E. Melnikov, St.-Petersburg, Russia  
+7(812)5526303; e-mail: kafedra@ksm.spbstu.ru

Sergey G. Semenov, St.-Petersburg, Russia  
+7(921)9834456; e-mail: ssgrus@gmail.com

© Nekliudova E.A., Semenov A.S., Melnikov B.E., Semenov S.G., 2014

doi: 10.5862/MCE.47.3

## Experimental research and finite element analysis of elastic and strength properties of fiberglass composite material

**Undergraduate E.A. Nekliudova**

*Saint-Petersburg State Polytechnical University, Saint-Petersburg, Russia*  
+79219253778; e-mail: nekludik@mail.ru

**PhD, Associate Professor A.S. Semenov**

*Saint-Petersburg State Polytechnical University, Saint-Petersburg, Russia*  
+79052721188; e-mail: Semenov.Artem@googlemail.com

**Dr.tech.sci., Head of Department B.E. Melnikov**

*Saint-Petersburg State Polytechnical University, Saint-Petersburg, Russia*  
+78125526303; e-mail: kafedra@ksm.spbstu.ru

**Engineer S.G. Semenov**

*Saint-Petersburg State Polytechnical University, Saint-Petersburg, Russia*  
+79219834456; e-mail: ssgrus@gmail.com

### Key words

laminated composite; fiberglass material; experiment; elastic properties; strength; orientation of the reinforcement; failure criteria; orthotropic material; finite-element method

### Abstract

This work is devoted to the research of the strength and elastic properties of the laminated fiberglass composite. Experiments were performed on tension and compression of specimens with different orientation of the reinforcement in relation to the loading direction. The predictions of three different failure criteria (Hill criterion, Tsai-Wu criterion, Zakharov criterion) were compared to experimental results.

The strength and elastic properties of the composite separate components have been also researched with the aim to perform finite element simulation of composite failure process. The elastic moduli of the composite are determined by means of the method of the finite element homogenization.

### References

1. Paranicheva N.V., Nazmeyeva T.V. Usileniye stroitelnykh konstruktsiy s pomoshchyu uglerodnykh kompozitsionnykh materialov [Strengthening of building structures using carbon composite materials]. *Magazine of Civil Engineering*. 2010. No. 2(12). Pp. 19–22. (rus)
2. Klyuyev S.V., Guryanov Yu.V. Vneshneye armirovaniye izgibayemykh fibrobetonnykh izdeliy uglevoloknom [External reinforcing of fiber concrete constructions by carbon fiber tapes]. *Magazine of Civil Engineering*. 2013. No. 1(36). Pp. 21–26. (rus)
3. Morozova T.S., Kuznetsov V.D. Vneshneye armirovaniye zhelezobetonnykh kolonn kompozitsionnym materialom na osnove uglevolokon [External reinforcement of concrete columns with composite material based on carbon fibers]. *Magazine of Civil Engineering*. 2010. No. 3(13). Pp. 35–38. (rus)
4. Stolyarov O.N., Gorshkov A.S. Primeneniye vysokoprochnykh tekstilnykh materialov v stroitelstve [Use high-strength textile materials in construction]. *Magazine of Civil Engineering*. 2009. No. 4(6). Pp. 21–25. (rus)
5. Stolyarov O.N., Stolyarov I.N., Kryachkova T.A., Kravaev P.G. Hybrid textile yarns and thermoplastic composites based on them. *Fibre Chemistry*. 2013. No. 4. Pp. 217–220.
6. Echaabi J., Trochu F., Gauvin R. Review of failure criteria of fibrous composite materials. *Polymer Composites*. 1996. No. 6. Pp. 786–798.
7. Moncada A.M., Chattopadhyay A., Bednarczyk B.A., Arnold S.M. Micromechanics-based progressive failure analysis of composite laminates using different constituent failure theories. *Journal of Reinforced Plastics and Composites*. 2012. No. 31. Pp. 1467–1487.
8. Kaddour A.S., Hinton M.J. Maturity of 3D failure criteria for fibre-reinforced composites: Comparison between theories and experiments: Part B of WWFE-II. *Journal of Composite Materials*. 2013. No. 47. Pp. 925–966.
9. Qian Y., Zhou G., Cai D., Liu W. Investigation of strength criterion for biaxial fiber-reinforced composite laminated plates. *Journal of Nanjing University of Aeronautics and Astronautics*. 2013. No. 45. Pp. 179–185.



10. Li H., Kandare E., Li S., Wang Y., Kandola B.K., Myler P., Horrocks A.R. Micromechanical finite element analyses of fire-retarded woven fabric composites at elevated temperatures using unit cells at multiple length scales. *Computational Materials Science*. 2012. No. 55. Pp. 23–33.
11. Kalamkarov A.L., Challagulla K.S. Effective properties of composite materials, reinforced structures and smart composites: Asymptotic homogenization approach. *Solid Mechanics and its Applications*. 2013. No.193. Pp.283–363.
12. Li H., Fan X., Yan C. Prediction of orthotropic mechanical properties of plain-weave composites with matrix voids using unit cells at multi-scales. *Polymer International*. 2013. No. 62. Pp. 1029–1037.
13. Fedorov I.V., Semenov S.G., Semenov A.S., Melnikov B.Ye. Analiz prochnosti, ustoychivosti i zhestkosti vodovoda iz kompozitsionnogo materiala [An analysis of strength, buckling and rigidity of composite material water piping]. *St. Petersburg State Polytechnical University Journal. Physics and Mathematics*. 2012. No. 4 (158). Pp. 126–134. (rus)
14. TU 6-48-53-90. *Tkani steklyannyye marok T-23 i T-23R. Tekhnicheskiye usloviya* [Textile glass grades T-23 and T-23P. Specifications]. (rus)
15. Vasiliev V.V., Morozov E.V. *Mechanics and analysis of composite materials*. Oxford: Elsevier Science Ltd., 2001. 430 p.
16. Kim R.Y., Abrams F., Knight M. Mechanical characterization of a thick composite laminate. In: *Proceedings of American Society of Composites, 3rd Technical Conference*. Seattle, Washington, USA, September 1988. Pp. 711–718.
17. Vasilyev V.V. *Mekhanika konstruksiy iz kompozitsionnykh materialov* [Mechanics of composite structures]. Moscow: Mashinostroyeniye, 1988. 272 p. (rus)
18. Tsai S.W., Wu E.M. A General Theory of Strength for Anisotropic Materials. *Journal of Composite Materials*. 1971. No. 5. Pp. 58–80.
19. Malinin N.N. *Prikladnaya teoriya plastichnosti i polzuchesti* [Applied Theory of Plasticity and Creep]. Moscow: Mashinostroyeniye, 1975. 400 p. (rus)
20. Kristensen R.M. *Mekhanika kompozitsionnykh materialov* [Mechanics of Composite Materials]. Moscow: Mir, 1982. 336 p. (rus)
21. Christensen R.M. The Number of Elastic Properties and Failure Parameters for Fiber Composites. *Journal of Engineering Material and Technology*. 1998. Vol. 120(2). Pp. 110–113.
22. Hill R. *The mathematical theory of plasticity*. Oxford: Clarendon Press, 1950. 392 p.
23. Steven J. DeTeresa, Gregory J. Larsen. Reduction in the Number of Independent Parameters for the Tsai–Wu Tensor Polynomial Theory of Strength for Composite Materials. *Journal of Composite Materials*. 2003. No. 19. Pp. 1769–1785.
24. Sulaimana S., Borazjani S., Tang S.H. Finite element analysis of filament-wound composite pressure vessel under internal pressure. *IOP Conference Series: Materials Science and Engineering*. 2013. Vol. 50. No. 1. 012061
25. Goldenblat I.I., Kopnov V.A. *Kriterii prochnosti i plastichnosti konstruksionnykh materialov* [The criteria of strength and ductility of structural materials]. Moscow: Mashinostroyeniye, 1968. 192 p. (rus)
26. GOST 25.601–80. *Raschety i ispytaniya na prochnost. Metody mekhanicheskikh ispytaniy kompozitsionnykh materialov s polimernoy matritsey (kompozitov). Metod ispytaniya ploskikh obratsov na rastyazheniye pri normalnoy, povyshennoy i ponizhennoy temperaturakh* [Calculations and tests of strength. Methods of mechanical testing of composite materials with a polymer matrix (composites). Test Method for Tensile flat samples with normal, low and high temperatures]. (rus)
27. GOST 25.602–80. *Raschety i ispytaniya na prochnost. Metody mekhanicheskikh ispytaniy kompozitsionnykh materialov s polimernoy matritsey (kompozitov). Metod ispytaniya na szhatiye pri normalnoy, povyshennoy i ponizhennoy temperaturakh* [Calculations and tests of strength. Methods of mechanical testing of composite materials with a polymer matrix (composites). The method of compression testing of flat samples with normal, low and high temperatures]. (rus)
28. Wu. E.M. Optimal Experimental Measurements of Anisotropic Failure Tensors. *Journal of Composite Materials*. 1972. No. 6. Pp. 472–489.
29. Spoomaker, J., Skrypnyk, I., Stolyarov, O.N., Tiranov, V.G., Heidweiller, A.J. Mechanical properties of plastics for FEM calculations. *ANTEC conference proceedings*. 2004. No. 3. Pp. 3893–3897.
30. Besson Zh., Kayeto Zh., Shabosh Zh.-L., Forest S. *Nelineynaya mekhanika materialov* [Nonlinear Mechanics of Materials]. Saint-Petersburg: SPbGPU, 2010. 397 p. (rus)

**Full text of this article in Russian: pp. 25–39**